



**BOAT B35**

PURPOSE: popular steel trailers for the transport of boats, pontoons, jet skis

COMFORT: high possibility of adjusting the place of installation of the equipment

SAFETY: high quality keel and side rollers, side supports, solid tie down points

CONVENIENCE: adjustable and removable light bar

CONSTRUCTION: welded frame from B05 model, low center of gravity



ANWENDUNG: beliebte Stahlanhänger für den Transport von Booten, Pontons, Jetskis

KOMFORT: hohe Anpassungsfähigkeit des Installationsortes der Ausstattung

SICHERHEIT: hochqualitative Kiel- und Seitenrollen, Seitenstützen, zuverlässige Verzurrpunkte

SPEZIALBEDARF: verstellbarer und abnehmbarer Lichtbalken

KONSTRUKTION: geschweißter Rahmen ab B05 Modell, tiefer Schwerpunkt



UTILISATION: remorques en acier pour le transport de bateaux, jets et pontons

CONFORT: réglage d'équipement confortable

SÉCURITÉ: rouleaux de quille et supports latéraux de haute qualité, dispositifs de fixation des sangles solides

COMMODITÉ: rampe d'éclairage réglable et amovible

CONSTRUCTION: châssis soudé à partir du modèle B05, centre de gravité bas



PRZEZNACZENIE: popularne przyczepy stalowe do przewozu łodzi, pontonów, skuterów

WYGODA: duża możliwość regulacji miejsca montażu wyposażenia

BEZPIECZEŃSTWO: wysokiej jakości rolki kilowe i boczne, podpory boczne, solidne mocowanie pasów

UDOGODNIENIA: regulowana i wyjmowana belka oświetleniowa

KONSTRUKCJA: rama spawana od modelu B05, niski środek ciężkości

BOAT

JET



B400/18



B500/18



B600/18



B13/076/21V



B15/076/21V



B18/076/21V



B20/076/21V



B25/086/21V

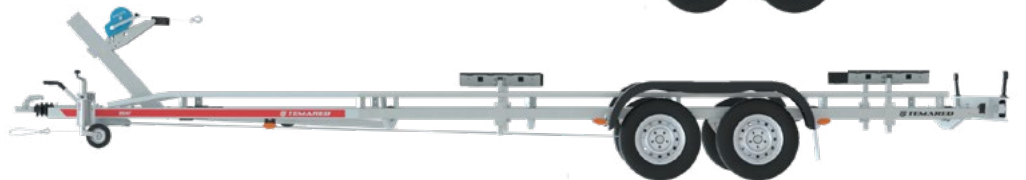

B35/3 T

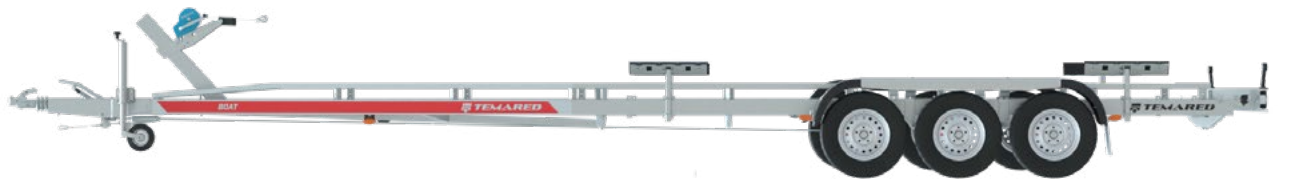

B35/096/23/3 T

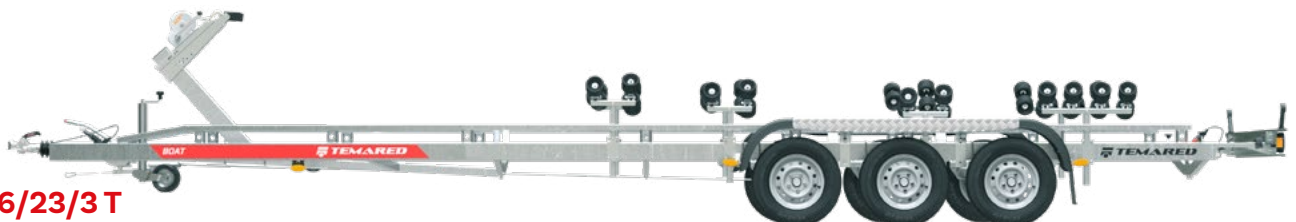

- JET supports ensure stable securing of the hull with correct mass distribution
- JET-Seitenstützen gewährleisten eine stabile Rumpfbefestigung und eine korrekte Gewichtsverteilung
- Patins plats JET assurent une fixation stable du coque et une répartition adéquate de son poids
- podpory boczne JET zapewniają stabilne umocowanie kadłuba i prawidłowy rozkład jego masy



JET

- high adjustability of the bow stopper
- verstellbare Bugstütze
- possibilité d'ajuster la butée d'étrave
- możliwość regulacji dziobnicy

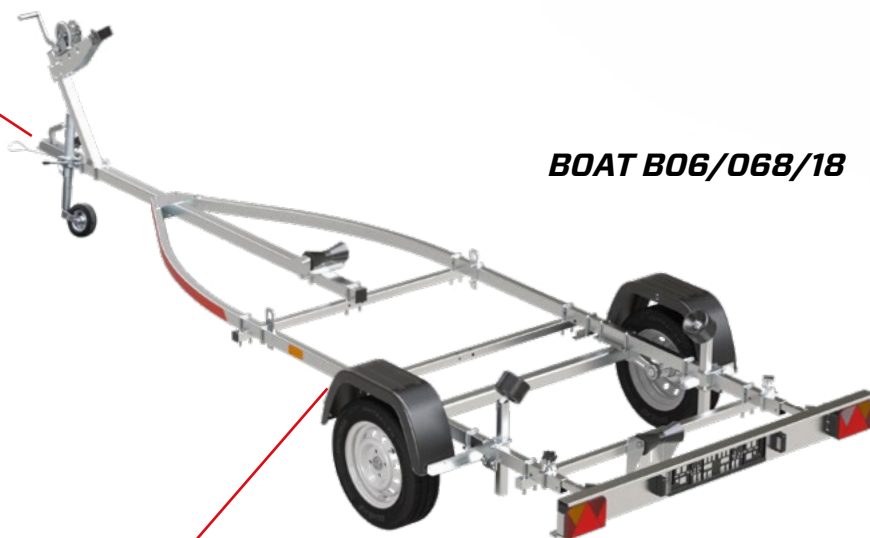

BOAT B06/068/18

- B04/040/16, B05/050/18, B06/060/18: construction bolted using u-bolts, with easy adjustable length of the trailer
- B04/040/16, B05/050/18, B06/060/18: einfache Anpassung der Länge des Anhängers
- B04/040/16, B05/050/18, B06/060/18: construction boulonnée (U-boulons), réglage facile de la longueur de la remorque
- B04/040/16, B05/050/18, B06/060/18: konstrukcja skręcana na cybantach, łatwość regulacji długości przyczepy

- four adjustable tie down points
- vier verstellbare Befestigungspunkte
- quatre points de fixation réglables
- cztery regulowane punkty mocowania

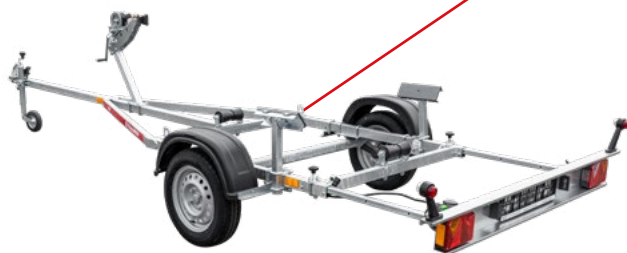

BOAT B05/058/18

- high adjustable keel roller
- Kielrolle höhenverstellbar
- possibilité d'ajuster la hauteur du rouleau de quille
- możliwość regulacji wysokości rolki kilowej



- possibility to pull out and move the rear light bar
- Möglichkeit den hinteren Balken herauszuziehen und abzunehmen
- possibilité de régler et de démonter la rampe d'éclairage
- możliwość wysunięcia i demontażu tylnej belki

- new profile shape and license plate mounting
- neue Gestalt des Profils und neue Befestigung des Kennzeichens
- nouvelle forme des profils et fixation de la plaque d'immatriculation
- nowy kształt profili oraz mocowanie tablicy rejestracyjnej



BOAT B04/048/16



- possibility to pull out and remove the rear light beam
- Möglichkeit den hinteren Balken herauszuziehen und abzunehmen
- possibilité de régler et de démonter la rampe d'éclairage
- możliwość wysunięcia i demontażu tylnej belki

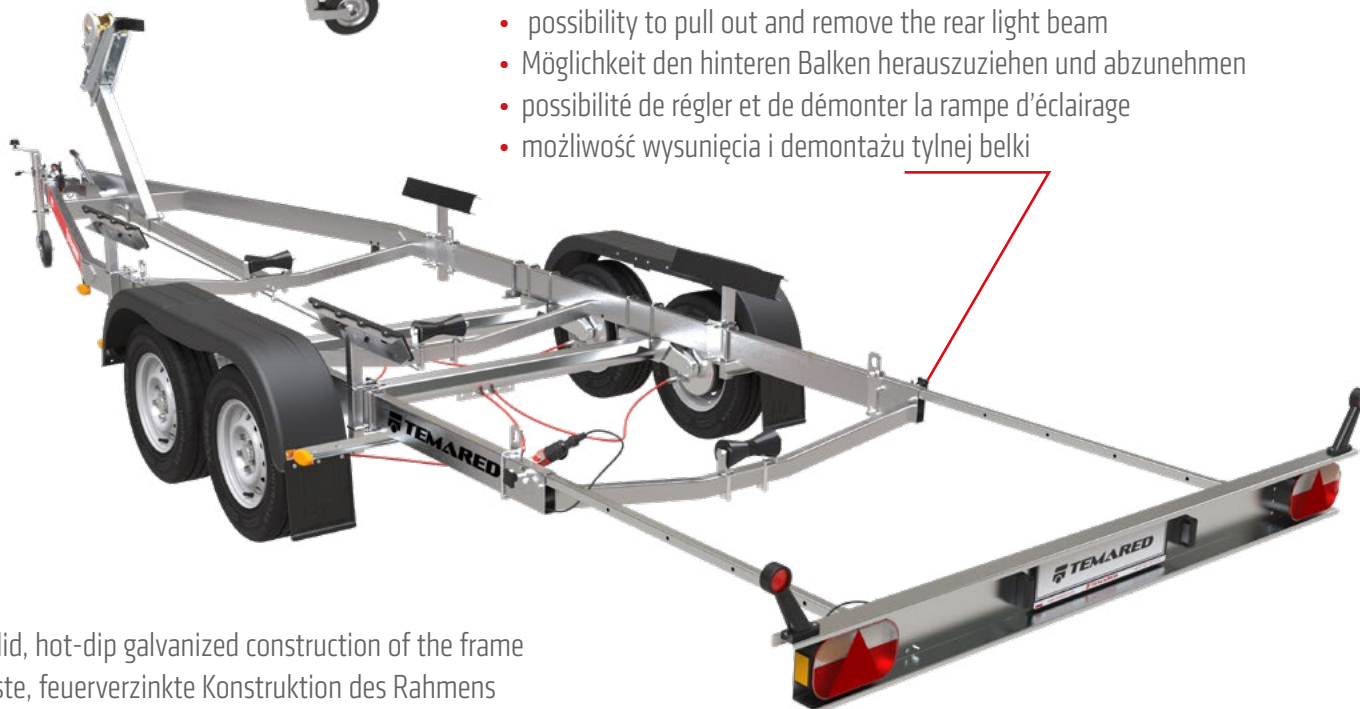

- solid, hot-dip galvanized construction of the frame
- feste, feuerverzinkte Konstruktion des Rahmens
- construction robuste du châssis, galvanisée, résistante à la corrosion
- wytrzymała konstrukcja ramy, zabezpieczona antykorozyjnie ocynkiem

BOAT B20/076/21 V



BOAT B35/3

- functional bow stopper with winch
- funktionelle Bugstütze mit der Winde
- butée d'étrave fonctionnelle avec le treuil
- funkcjonalna dziobnica z wciągarką

- easy adjustment of side supports and possibility of adding extra rollers, extra bolted crossbeams
- Möglichkeit die Stützen zu konfigurieren, und bestellen die zusätzliche Ausstattung: untere Querstreben, Seitenstützen, Seitenrollen
- possibilité de configurer les supports latéraux selon vos besoins et de commander des éléments supplémentaires tels que traverses, supports latéraux ou rouleaux de quille
- możliwość swobodnego konfigurowania podpór bocznych, oraz zamówienia dodatkowych elementów typu: poprzeczki denne, podpory boczne, rolki boczne

**BOAT B35/3**

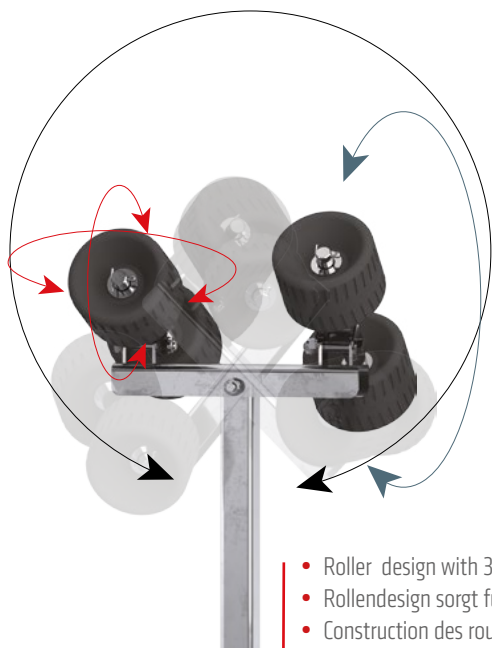

• PRLZ1 400 • PRLZ2 400 • PRLZ4 500 • PRLZ8 500

- Roller design with 30° of tilting movement all directions ensuring a proper boat support
- Rollendesign sorgt für freie Haftung an den Ebenen des Rumpfes
- Construction des rouleaux permet de s'adapter facilement à la coque
- Konstrukcja rolek zapewnia swobodne przyleganie do płaszczyzn kadłuba



- Flat side support PZ1 400
- Seitenstütze PZ1 400
- Patin plat PZ1 400
- Podpora płaska PZ1 400



- Adjustable side support TTL
- Höhenverstellbare Seitenstütze TTL
- Patin plat à hauteur réglable TTL
- Podpory o regulowanej wysokości TTL



- Flat side support PZ2 400
- Seitenstütze PZ2 400
- Patin plat PZ2 400
- Podpora płaska PZ2 400

- Flat side support JET 400
- Stoffebespannte Seitenstütze JET 400
- Patin plat JET 400
- Podpora płaska JET 400





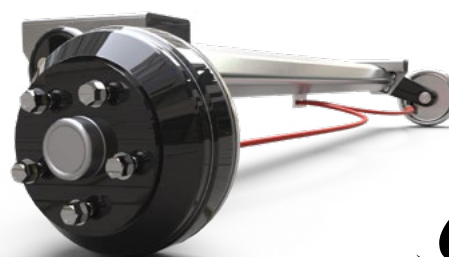







- Cradle roller RKZ2
- Doppelrolle RKZ2
- Balancier double RKZ2
- Rolki typu kołyska RKZ2



 1	 2	 3	 4	 5
spare wheel support	shock absorbers	AKS	automatic jockey wheel	additional tie down point
Ersatzradhalter	Achsstoßdämpfer	Antischlingerkupplung	Automatiktstützrad	zusätzliche Gurtbefestigung
Support de la roue de secours	amortisseurs	AKS	roue jockey automatique	anneau d'arrimage supplémentaire
wspornik koła zapasowego	amortyzatory	AKS	koło podporowe automatyczne	dotatkowe mocowanie pasów
 6	 7	 8	 9	
small bow stopper (trailers up to 1000 kg), adjustable bow stopper standard	big bow stopper (trailers from 1300 kg), adjustable bow stopper standard	big bow stopper with double V (trailers from 1300 kg)	adjustable side support TTL	
Bugstütze klein (Anhänger bis 1000 kg), Bugstützen mit Winkel- und Höhenverstellung als Standard	Bugstütze groß (Anhänger ab 1300 kg), Bugstützen mit Winkel- und Höhenverstellung als Standard	Bugstütze groß mit doppel-V (Anhänger ab 1300 kg)	höhenverstellbare Seitenstütze TTL	
petite butée d'étrave (remorques jusqu'à 1000kg incluses), butée d'étrave réglable en série	grande butée d'étrave (remorques à partir de 1300kg), butée d'étrave ajustable en série	grande butée d'étrave avec double V (remorques à partir de 1300kg)	patin plat à hauteur réglable TTL	
dziobnica mała (do przyczep do 1000 kg włącznie) dziobnice z regulacją kąta i wysokości w standardzie	dziobnica duża (od przyczep 1300 kg), dziobnice z regulacją kąta i wysokości w standardzie	dziobnica duża z podwójnym V (od przyczep 1300 kg)	podpory o regulowanej wysokości TTL	

	Side supports version Version Seitenstützen Version patins plats Wersja z podporami bocznymi	Side rollers version Version Rollenstützen Version rouleaux Wersja z rolkami	crossbeam + keel roller, qty in standard Querträger + Kielrolle, Anzahl in Serienausstattung Traverse + rouleau de quille, quantité en série Poprzeczka + Rolka denna, ilość w standardzie	1	2	3	4	5	6	7	8	9
B04/048/16	2 x PZ1 400	2 x PRLZ1 400	2 + 2	□	-	-	-	■	■	-	-	-
B05/058/18	2 x PZ1 400	2 x PRLZ1 400	2 + 2	□	-	-	-	■	■	-	-	-
B06/068/18	2 x PZ1 400	2 x PRLZ1 400	2 + 2	□	-	-	-	■	■	-	-	-
JET	2 x JET 400	-	2 + 2	□	-	-	-	■	■	-	-	-
B05	2 x PZ1 400	2 x PRLZ2 400	2 + 2	□	-	-	-	■	■	-	-	-
B13/076/21 V	4 x PZ2 400	4 x PRLZ2 400	3 + 3	□	□	□	-	■	-	■	□	-
B15/076/21 V	4 x PZ2 400	4 x PRLZ2 400	3 + 3	□	□	□	-	■	-	■	□	-
B18/076/21 V	4 x PZ2 400	4 x PRLZ2 400	3 + 3	□	□	□	-	■	-	■	□	-
B20/076/21 V	4 x PZ2 400	4 x PRLZ2 400	3 + 3	□	□	□	-	■	-	■	□	-
B25/086/21 V	4 x PZ2 400	4 x PRLZ2 400	5 + 5	□	□	□	-	□	-	■	□	-
B35	4 x PZ2 400	4 x PRLZ2 400 2 x PRLZ4 400	6 + 6	□	□	□	■	□	-	■	□	□
B35/3 T	4 x PZ2 400	4 x PRLZ2 400 2 x PRLZ4 400	6 + 6	□	□	□	■	□	-	■	□	□
B35/096/23 V/3 T	4 x PZ2 400	4 x PRLZ2 400 2 x PRLZ4 400	6 + 6	□	□	□	■	□	-	■	□	□

■ standard □ option - unavailable

MODEL MODELL MODÈLE MODEL	GVWR(kg) zGG (kg) PTAC (kg) DMC (kg)	LOAD CAPACITY(kg) NUTZLAST(kg) CAPACITÉ DE CHARGE(kg) ŁADOWNOŚĆ(kg)	MAX. DIM. EXT. MAX. AUB. GRÖß. DIM. EXT. MAX. MAX. WYM. ZEW.	MAX. DIM. INT. MAX. INN. GRÖß. DIM. INT. MAX. MAX. WYM. WEW.	SUSPENSION AUFHÄNGUNG SUSPENSION ZAWIESZENIE	WHEELS RÄDER ROUES KOŁA	FRAME WIDTH (mm) RAHMENBREITE (mm) LARGEUR DU CHÂSSIS (mm) SZEROKOŚĆ RAMY (mm)
B04/048/16	400	275	4000 x 1560	3443 x 1560		155/70 R13 4X100	1040
B05/058/18	750	615	5000 x 1750	4443 x 1751		155/70 R13 4X100	1230
B06/068/18	750	606	6000 x 1751	5443 x 1751		155/70 R13 4X100	1230
JET	750	588	5450 x 1765	4380 x 1765		155/70 R13 4X100	1230
B05	750	598	5970 x 1765	5180 x 1765		155/70 R13 4X100	1230
B13/076/21 V	1300	991	7600 x 2180	6430 x 1720		165 R13C 5X112	1530
B15/076/21 V	1500	1172	7550 x 2200	6170 x 2200		185 R14C 5X112	1530
B18/076/21 V	1800	1442	7550 x 2200	6170 x 2200		185 R14C 5X112	1530
B20/076/21 V	2000	1612	7550 x 2200	6170 x 2200		165 R13C 5X112	1530
B25/086/21 V	2500	2250	8590 x 2200	7260 x 2200		165 R13C 5X112	1530
B35	3500	2869	9570 x 2415	8230 x 2415		185 R14C 5X112	1730
B35/3 T	3500	2839	9570 x 2415	8230 x 2415		165 R13C 5X112	1730
B35/096/23 V/3 T	3500	2822	10840 x 2530	9160 x 2530		185 R14C 5X112	1830



1 non-braked axle
1 Achse ungebremst
1 essieu non freiné
1 oś niehamowana



1 braked axle
1 Achse gebremst
1 essieu freiné
1 oś hamowana



2 braked axles
2 Achsen gebremst
2 essieux freinés
2 osie hamowane



3 braked axles
3 Achsen gebremst
3 essieux freinés
3 osie hamowane

MAX. DIM. EXT. / MAX. WYM. ZEW.

MAX. DIM. INT. / MAX. WYM. WEW.



BOAT B15/076/21 V



BOAT ALU B35



PURPOSE: special aluminium boat for transporting boats, yachts, jets

COMFORT: high adjustability of equipment

SAFETY: high quality keel and side rollers, side supports, robust tie down points

CONVIENIENCE: adjustable and removeable rear lightbeam, practical step aiding to stand on the mudguard

CONSTRUCTION: full aluminium, robust and lighter than steel models, fully resistant to corrosion



ZWECK: spezielle Serie von Aluminiumanhängern für den Transport von Booten, Yachten und Jetskis

KOMFORT: hohe Anpassungsfähigkeit der Ausrüstungsmontage

SICHERHEIT: hochwertige Kiel- und Seitenrollen, Seitenstützen, solide Befestigung der Gurte

PRAKTIKABILITÄT: verstellbarer und abnehmbarer Lichtbalken, praktische Trittstufe zum Aufsteigen auf den Kotflügel

KONSTRUKTION: aus Aluminium, stabiler und leichter als Stahlmodelle, völlig korrosionsbeständig



UTILISATION: série spéciale des remorques en aluminium pour le transport des bateaux, yachts et jet-skis

COMFORT: grande possibilité de régler la position du montage de l'équipement

SÉCURITÉ: rouleaux de quille et supports latéraux de haute qualité, dispositifs solides de fixation des sangles

COMMODITÉS: rampe d'éclairage réglable et amovible, marches confortables permettant d'entrer sur le garde-boue

CONSTRUCTION: en aluminium, solide, plus légère que les modèles en acier, totalement résistante à la corrosion



PRZEZNACZENIE: specjalna seria aluminiowych przyczep do przewozu łodzi, jachtów, skuterów

WYGODA: duża możliwość regulacji miejsca montażu wyposażenia

BEZPIECZEŃSTWO: wysokiej jakości rolki kilowe i boczne, podpory boczne, solidne mocowanie pasów

UDOGODNIENIA: regulowana i wyjmowana belka oświetleniowa, praktyczny schodek oraz stopnie umożliwiające wejście na błątnik

KONSTRUKCJA: wykonana z aluminium, mocna i lżejsza od modeli stalowych, całkowicie odporna na korozję



- Flat side support JET 400
- Stoffebespannte Seitenstütze JET 400
- Patin plat JET 400
- Podpora płaska JET 400

- Flat side support PD/PDG
- Stoffebespannte Seitenstütze PD/PDG
- Patin plat PD/PDG
- Podpora płaska PD/PDG



• PD

• PDG



- Cradle roller RKZ2
- Doppelrolle RKZ2
- Balancier double RKZ2
- Rolki typu kołyska RKZ2

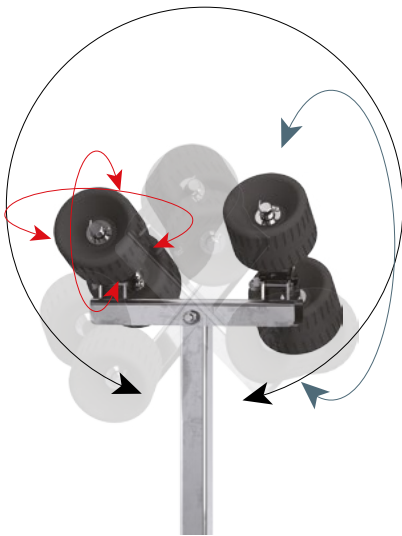

• PRLZ1 400

• PRLZ2 400

• PRLZ4 500

• PRLZ8 500

- roller design with 30° of tilting movement all directions ensuring a proper boat support
- Rollendesign sorgt für freie Haftung an den Ebenen des Rumpfes
- construction des rouleaux permet de s'adapter facilement à la coque
- konstrukcja rolek zapewnia swobodne przyleganie do płaszczyzn kadłuba



- Flat side support PZ1 400
- Seitenstütze PZ1 400
- Patin plat PZ1 400
- Podpora płaska PZ1 400



- Adjustable side support TTL
- höhenverstellbare Seitenstütze TTL
- Patin plat à hauteur réglable TTL
- Podpory o regulowanej wysokości TTL



- Flat side support PZ2 400
- Seitenstütze PZ2 400
- Patin plat PZ2 400
- Podpora płaska PZ2 400



1
spare wheel support
Ersatzradhalter
Support de la roue de secours
wspornik koła zapasowego



2
shock absorbers
Achsstoßdämpfer
amortisseurs
amortyzatory



3
AKS
Antischlingerkupplung
AKS
AKS



4
automatic jockey wheel
Automatiktstützrad
roue jockey automatique
koło podporowe automatyczne



5
additional tie down point
zusätzliche Gurtbefestigung
anneau d'arrimage supplémentaire
dodatkowe mocowanie pasów



6
small bow stopper (trailers up to 1000 kg), adjustable bow stopper standard
Bugstütze klein (Anhänger bis 1000 kg), Bugstützen mit Winkel- und Höhenverstellung als Standard
petite butée d'étrave (remorques jusqu'à 1000kg incluses), butée d'étrave réglable en série
dziobnica mała (do przyczep do 1000 kg włącznie), dziobnice z regulacją kąta i wysokości w standardzie



7
big bow stopper (trailers from 1300 kg), adjustable bow stopper standard
Bugstütze groß (Anhänger ab 1300 kg), Bugstützen mit Winkel- und Höhenverstellung als Standard
grande butée d'étrave (remorques à partir de 1300kg), butée d'étrave ajustable en série
dziobnica duża (od przyczep 1300 kg), dziobnice z regulacją kąta i wysokości w standardzie



8
big bow stopper with double V (trailers from 1300 kg)
Bugstütze groß mit doppel-V (Anhänger ab 1300 kg)
grande butée d'étrave avec double V (remorques à partir de 1300kg)
dziobnica duża z podwójnym V (od przyczep 1300 kg)



9
Adjustable side support TTL
höhenverstellbare Seitenstütze TTL
Patin plat à hauteur réglable TTL
Podpory o regulowanej wysokości TTL

Side supports version
Version Seitenstützen
Version patins plats
Wersja z podporami bocznymi

Side rollers version
Version Rollenstützen
Version rouleaux
Wersja z rolkami

version with PD+PDG supports
Version mit PD+PDG Stützen
version avec supports PD+PDG
Wersja z podporami PD+PDG

crossbeam + keel roller, qty in standard
Querträger + Kielrolle, Anzahl in Serienausstattung
Traverse + rouleau de quille, quantité en série
Poprzeczka + Rolka denna, ilość w standardzie

1 2 3 4 5 6 7 8 9

B27 ALU	6 x PZ2	4 x PRLZ2	—	4 + 4	<input type="checkbox"/>	<input type="checkbox"/>	<input type="checkbox"/>	<input checked="" type="checkbox"/>	<input checked="" type="checkbox"/>	<input type="checkbox"/>	<input checked="" type="checkbox"/>	<input type="checkbox"/>	<input type="checkbox"/>
B35/2 ALU	6 x PZ2	4 x PRLZ2, 2 x PRLZ4	2xPD+2XPDG	4 + 4*	<input type="checkbox"/>	<input type="checkbox"/>	<input type="checkbox"/>	<input checked="" type="checkbox"/>	<input checked="" type="checkbox"/>	<input type="checkbox"/>	<input checked="" type="checkbox"/>	<input type="checkbox"/>	<input type="checkbox"/>
B35/3 ALU	6 x PZ2	4 x PRLZ2, 2 x PRLZ4	2xPD+2XPDG	4 + 4*	<input type="checkbox"/>	<input type="checkbox"/>	<input type="checkbox"/>	<input checked="" type="checkbox"/>	<input checked="" type="checkbox"/>	<input type="checkbox"/>	<input checked="" type="checkbox"/>	<input type="checkbox"/>	<input type="checkbox"/>
B35/3 ALU T	6 x PZ2	4 x PRLZ2, 2 x PRLZ4	2xPD+2XPDG	4 + 4*	<input type="checkbox"/>	<input type="checkbox"/>	<input type="checkbox"/>	<input checked="" type="checkbox"/>	<input checked="" type="checkbox"/>	<input type="checkbox"/>	<input checked="" type="checkbox"/>	<input type="checkbox"/>	<input type="checkbox"/>

PD - flat side support (textile) PDG - flat side support (textile + plastic) *PD+PDG: 4+0

■ standard □ option - unavailable

B 27 ALU



B 35/3 ALU

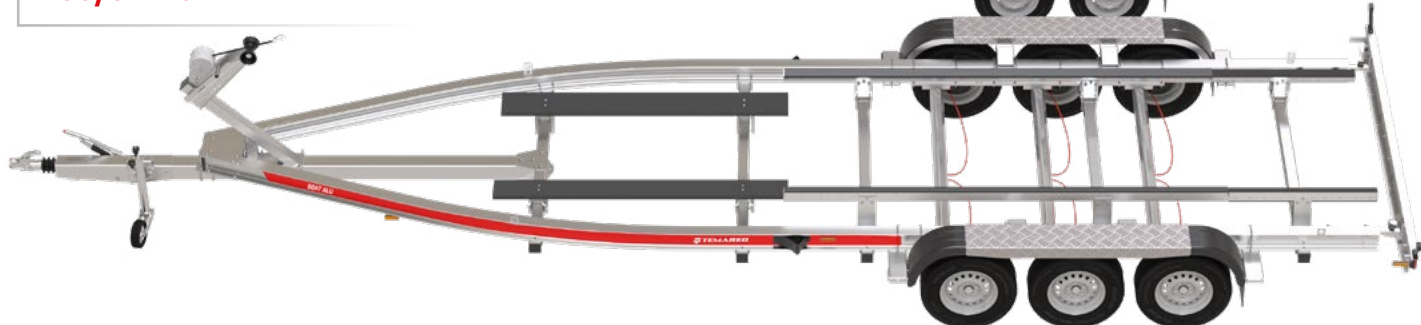

MODEL MODELL MODÈLE MODEL	GVWR (kg) zGG (kg) PTAC (kg) DMC (kg)	LOAD CAPACITY (kg) NUTZLAST (kg) CAPACITÉ DE CHARGE (kg) ŁADOWNOŚĆ (kg)	MAX. DIM. EXT. MAX. AUß. GRÖß. DIM. EXT. MAX. MAX. WYM. ZEWN.	MAX. DIM. INT. MAX. INN. GRÖß. DIM. INT. MAX. MAX. WYM. WEWN.	SUSPENSION AUFHÄNGUNG SUSPENSION ZAWIESZENIE	WHEELS RÄDER ROUES KOŁA	FRAME WIDTH (mm) RAHMENBREITE (mm) LARGEUR DU CHÂSSIS (mm) SZEROKOŚĆ RAMY (mm)
B27 ALU	2700	2236	8800 x 2410	7480 x 2390		165 R13C 5X112	1790
B35/2 ALU	3500	2918	9800 x 2410	7480 x 2390		185 R14C 5X112	1790
B35/3 ALU	3500	2898	9800 x 2410	7480 x 2390		165 R13C 5X112	1790
B35/2 T ALU	3500	2776	10840 x 2530	9130 x 2530		185R14C 5,5X14	1890
B35/3 PTZ ALU	3500	2776	10840 x 2530	9130 x 2530		165 R13C 5X112	1890



1 non-braked axle
1 Achse ungebremst
1 essieu non freiné
1 oś niehamowana



1 braked axle
1 Achse gebremst
1 essieu freiné
1 oś hamowana



2 braked axles
2 Achsen gebremst
2 essieux freinés
2 osie hamowane



3 braked axles
3 Achsen gebremst
3 essieux freinés
3 osie hamowane

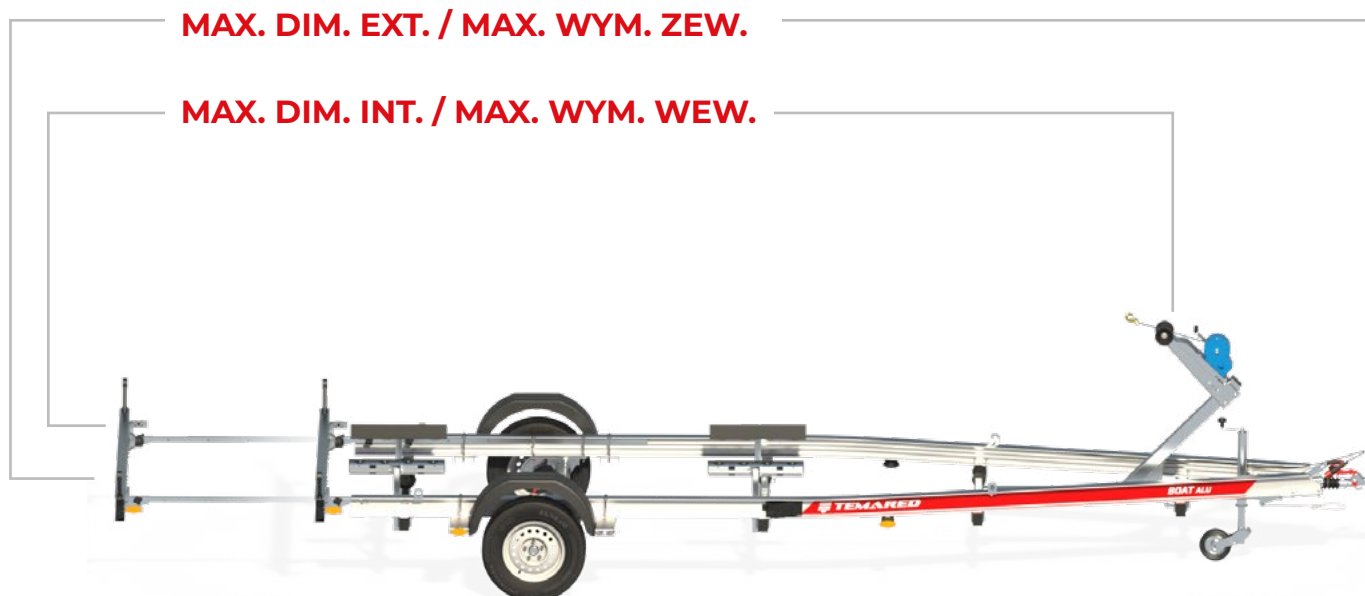

MAX. DIM. EXT. / MAX. WYM. ZEWN.

MAX. DIM. INT. / MAX. WYM. WEWN.

BOAT ALU B18

- adjustable and removeable lightbeam
- Hinterer Balken kann herausgezogen und demontiert werden
- possibilité d'allonger et de démonter la rampe d'éclairage
- możliwość wysunięcia i demontażu tylnej belki

- fully bolted, no welded parts
- keine geschweißten Teile, vollständig verschraubt
- sans éléments soudés, entièrement boulonnée
- brak elementów spawanych, w pełni skręcana



BOAT ALU B35/3

- thanks to the use of „T”-type drawbar, the internal length is longer by 1100mm compared to trailers with „V”-type drawbar
- dank der T-Deichsel gewinnen Sie 1100 mm an Ladefläche gegenüber dem Modell mit V-Deichsel
- grâce à l'utilisation d'un timon en T, on gagne 1100 mm d'espace de chargement par rapport aux modèles avec timon en V
- dzięki zastosowaniu dyszla typu T zyskujemy 1100 mm przestrzeni ładunkowej w stosunku do modelu z dyszlem V

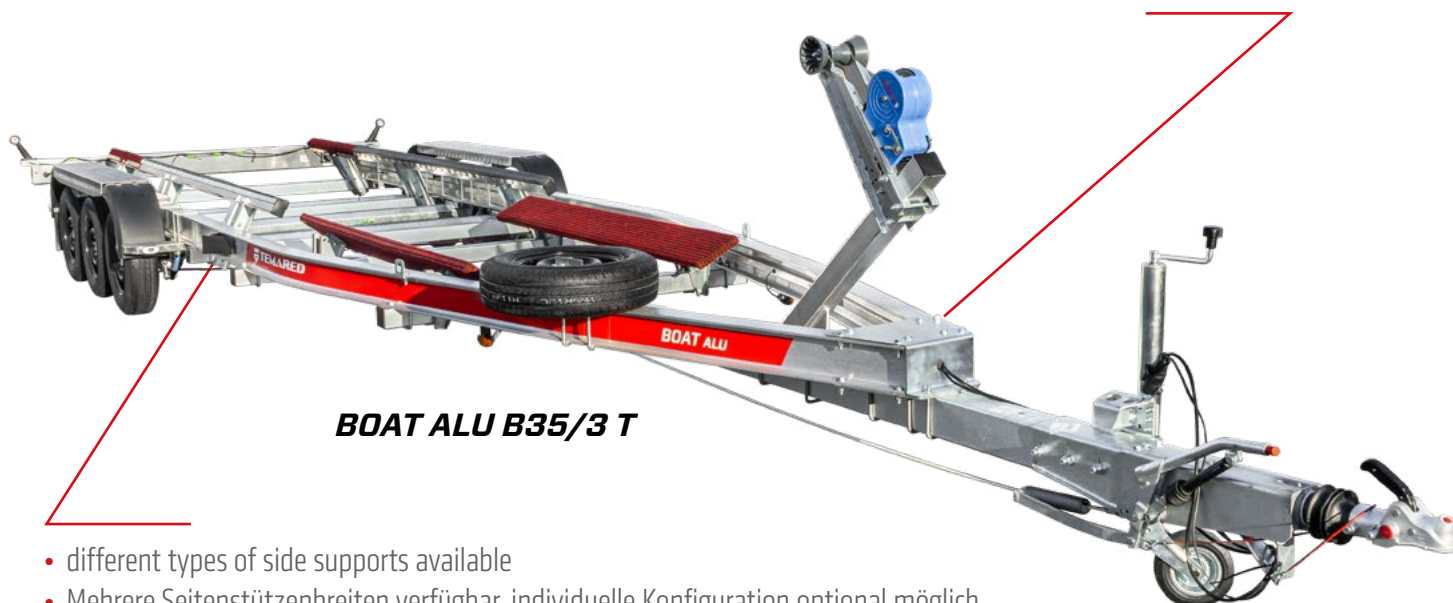

BOAT ALU B35/3 T

- different types of side supports available
- Mehrere Seitenstützenbreiten verfügbar, individuelle Konfiguration optional möglich
- différents types de supports latéraux dans l'offre, possibilité de configurer individuellement en option
- kilka szerokości podpór bocznych w ofercie, możliwość indywidualnej konfiguracji jako opcja



NOTES

A series of horizontal dashed lines for writing notes.

Kontakt

TEMARED Sp. z o.o.
al. Lotników Polskich 1
21-040 Świdnik,
Poland

Contact

Sales Department
tel.: +48 81 451 15 32
email:
sales@temared.com

www.temared.com

Full configuration of accessories and GVW R (kg) versions, available on the website. Vollständige Konfiguration des Zubehörs und der ZGG (kg) Versionen, verfügbar auf der Website. Configuration complète des accessoires et des versions PTAC (kg), disponible sur le site web. Pełna konfiguracja akcesoriów oraz wersji DMC (kg), dostępne na stronie internetowej.

Dear all! Thank you for your interest in our products. We make every effort to ensure that the information contained in this catalogue is up-to-date and accurate. We would like to inform you that due to the continuous improvement of our products, we are not responsible for the content of the catalogue and the information contained therein is not binding, and their nature is only informative, they do not constitute an offer within the meaning of civil law. This catalogue does not contain any promise or guarantee, also regarding the updating, correction, supplementation and quality of the information. All information contained in this catalogue, as well as the described products and services may be changed or updated by TEMARED Sp. z o.o. The „TEMARED” trademark, as well as its products, logos, symbols and slogans are the property of TEMARED Sp. z o.o. Unauthorized use of these trademarks is strictly prohibited.

Sehr geehrte Damen und Herren! Herzlichen Dank für Ihr Interesse an unseren Produkten. Wir bemühen uns unsererseits, dass die in diesem Katalog enthaltenen Informationen aktuell und korrekt sind. Wir möchten Sie darauf hinweisen, dass wir aufgrund der ständigen Verbesserung unserer Produkte keine Verantwortung für den Inhalt des Katalogs übernehmen und die darin enthaltenen Informationen unverbindlich sind, rein informativen Charakter haben und kein Angebot im Sinne des Zivilrechts darstellen. Dieser Katalog enthält keinerlei Versprechungen oder Garantien, auch nicht hinsichtlich der Aktualität, Korrektheit, Ergänzung und Qualität der Informationen. Alle in diesem Katalog enthaltenen Informationen sowie die beschriebenen Produkte und Dienstleistungen können von TEMARED Sp. z o.o. ohne vorherige Ankündigung geändert oder aktualisiert werden. Die Marke „TEMARED” sowie ihre Produkte, Logos, Symbole und Slogans sind Eigentum der TEMARED Sp. z o.o. Die unberechtigte Verwendung dieser Marken ist strengstens untersagt.

Mesdames et Messieurs, nous remercions de votre intérêt pour nos produits. Toutes les informations de ce catalogue ont été élaborées sur la base des meilleures informations disponibles et contrôlées avec le plus grand soin. Cependant il n'est pas possible d'exclure toute erreur liée aux modifications de nos produits que nous nous appliquons constamment à corriger ou modifier. C'est pourquoi les données proposées n'impliquent aucune obligation, garantie ni explicite ni implicite particulièrement quant à la nature, la commercialisation, l'aptitude pour les applications prévues. Nous nous réservons le droit de réaliser des modifications ou changements sans notification préalable. TEMARED SP Z O.O. a le droit d'exécuter les changements décrits ci-dessus aux informations, aux produits et aux services à tout moment. Les photos incluses dans ce catalogue appartiennent exclusivement à TEMARED SP Z O.O. detient l'ensemble des droits de propriété de logo, de la marque de TEMARED, de ses symboles, noms commerciaux et slogans. Il est interdit d'utiliser le logo ou la marque de TEMARED.

Szanowni Państwo! Bardzo dziękujemy za zainteresowanie naszymi produktami. Ze swojej strony dokładamy wszelkich starań aby zapewnić aktualność i dokładność informacji zawartych w tym katalogu. Pragniemy poinformować, że ze względu na ciągłe udoskonalenie produktów nie ponosimy odpowiedzialności w związku z treścią katalogu i informacje w nim zawarte nie są wiążące, a ich charakter jest wyłącznie informacyjny, nie stanowią one oferty w rozumieniu prawa cywilnego. Niniejszy katalog nie zawiera żadnego przyrzeczenia lub gwarancji, także odnośnie aktualizacji, korekcyj, uzupełnienia i jakości informacji. Wszystkie informacje zawarte w tym katalogu, jak również opisane produkty i usługi mogą być bez wcześniejszego zawiadomienia zmieniane lub aktualizowane przez TEMARED Sp. z o.o. Znak towarowy „TEMARED”, a także jej produkty, logo, symbole i slogany są własnością TEMARED Sp. z o.o. Nieuprawnione używanie tych znaków towarowych jest surowo zabronione.